

Technical Specification

Category: Holywell Plus

Part Number: 431291

Description: Holywell Plus Batten 4ft Twin 18W/36W 3CCT White
Plug & Play



Product Features:

- Single & Twin Outputs
- Unique opal diffuser design for optimum performance and light distribution
- Steel body construction with powder coat finish
- Conduit entry points at both ends
- Suitable for central BESA mounting
- Additional screw to secure end cap

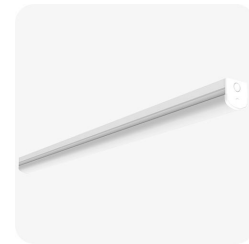

General information:

Wattage (W)	18 / 36
Lumens (lm)	2,900 / 5,750
Efficacy (lm/W)	160
Colour Temperature (K)	3000 / 4000 / 6000
IP Rating	20
IK Rating	6
Class Rating	1
Energy Rating	B
Flicker	Flicker Free
Dimmable	Fixed
L70 Hours	54000
L80 Hours	54000
L90 Hours	34000
Paint Finish (RAL)	9003

Technical information:

Application Location	Internal
Beam Angle	120
CRI	80
Input Type	220-240V AC
Driver Type	CC
Operating Temperature To	40
Product Warranty (Years)	5
Driver Brand	Lifud
Socket	N/A
Frequency (Hz)	50 60
Diffuser Material	Polycarbonate
Install Options	BESA/Conduit
Install Type	Push Fit Terminal
Replaceable Driver	Professional
Replaceable LED	Professional
Body Material	Steel
Maintained	Maintained/Non-Maintained
Sensor Technology	Microwave

Technical Specification

Category: Holywell Plus

Part Number: 431291

Description: Holywell Plus Batten 4ft Twin 18W/36W 3CCT White Plug & Play

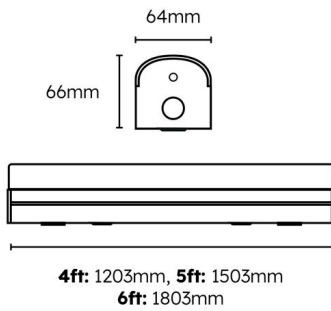

Compatible Products:



430916

Alwen Linear Microwave
Sensor 220-240V AC 200W
Max Plug & Play



401752

Alwen ON/OFF PIR External
Mount White (Batten)



430962

Grafham 3.5W Conversion
Pack 50-300V DC 0-40mA
LifePO4 3.2V DC 3.2Ah Plug &
Play E-SEL3 Emergency