

Technical Specification

Category: Holywell Plus

Part Number: 431291-MW

Description: Holywell Plus Batten 4ft Twin 18W/36W 3CCT White
Plug & Play Microwave



Product Features:

- Single & Twin Outputs
- Unique opal diffuser design for optimum performance and light distribution
- Steel body construction with powder coat finish
- Conduit entry points at both ends
- Suitable for central BESA mounting
- Additional screw to secure end cap
- High efficiency 160lm/W



General information:

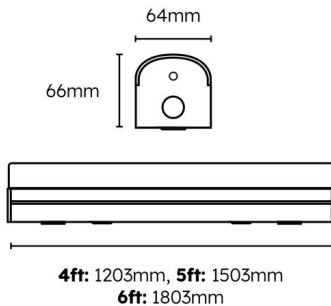

Technical information:

Technical Specification

Category: Holywell Plus

Part Number: 431291-MW

Description: Holywell Plus Batten 4ft Twin 18W/36W 3CCT White
Plug & Play Microwave



Compatible Products:



430916

Alwen Linear Microwave
Sensor 220-240V AC 200W
Max Plug & Play



401752

Alwen ON/OFF PIR External
Mount White (Batten)



430962

Grafham 3.5W Conversion
Pack 50-300V DC 0-40mA
LifePO4 3.2V DC 3.2Ah Plug &
Play E-SEL3 Emergency