

Technical Specification



Category: Foremark Single Wattage

Part Number: 430734-90

Description: Foremark High Bay 150W 5000K IP65 90D Plug & Play (Zhaga)



Product Features:

- Supplied with 1.5M prewired H05RN-F cable
- Sosen LED Driver
- 90° or 120° optic options
- Plug & Play Enabled – Sensors and Emergency



General information:

Wattage (W)	150
Lumens (lm)	21750
Efficacy (lm/W)	145
Colour Temperature (K)	5000
IP Rating	65
IK Rating	8
Class Rating	1
Energy Rating	C
Dimmable	truSmart
L70 Hours	60000
Paint Finish (RAL)	9017

Technical information:

Application Location	Internal
Emergency Output (lm)	650
Beam Angle	90
Optics	Symmetric
CRI	80
Input Type	120-240V AC
Driver Type	CC
Operating Temperature From	-30
Operating Temperature To	50
Product Warranty (Years)	5
Driver Brand	Sosen
Socket	Zhaga
Frequency (Hz)	50 60
Diffuser Material	Polycarbonate
Install Options	BESA/Conduit
Install Type	1.5m H05RN-F
Replaceable Driver	Professional
Replaceable LED	Professional
Body Material	Aluminium
Maintained	Maintained/Non-Maintained
Sensor Technology	Microwave

Technical Specification

Category: Foremark Single Wattage

Part Number: 430734-90

Description: Foremark High Bay 150W 5000K IP65 90D Plug & Play (Zhaga)

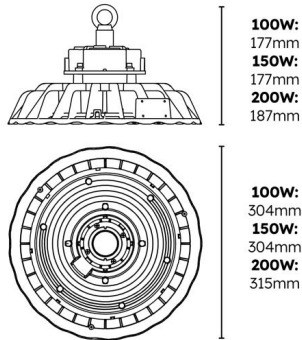

Compatible Products:



401754

Alwen PIR Highbay Remote



430569

Alwen Plug & Play 12V Microwave Sensor 12M Black (Zhaga)



430568

Alwen Plug & Play 12V PIR Sensor Black (Zhaga)



401063

Foremark (All Wattages) & Meadley 200W PC Diffuser With Cover



430341

Foremark Adjustable Bracket 3 Part



430965-R2

Grafham 4W E-SEL3 High Bay Emergency Conversion Pack 20-55V DC 100mA LifePO4 6.4V DC 3.6Ah Plug & Play with Jack Leads



431173

Universal High Bay Rotatable Bracket



430625

truSmart Crown Zhaga Plug & Play 12V PIR Sensor Black