

Technical Specification

Category: Sutton

Part Number: 430038

Description: Sutton Batten 4ft Single 19W 4000K White



Product Features:

- Frosted, ribbed polycarbonate diffuser to reduce glare
- Improved thermals utilising aluminium back PCBs
- H3 - High Output Emergency 440lm option available
- Additional screw to secure end cap
- Push-fit terminals
- 20mm conduit entry



General information:

Wattage (W)	19
Lumens (lm)	3050
Efficacy (lm/W)	160
Colour Temperature (K)	4000
IP Rating	20
IK Rating	6
Class Rating	1
Energy Rating	B
Flicker	Flicker Free
Dimmable	Fixed
L70 Hours	50000
Paint Finish (RAL)	9003

Technical information:

Application Location	Internal
Beam Angle	120
CRI	80
Input Type	220-240V AC
Driver Type	CC
Operating Temperature To	40
Product Warranty (Years)	5
Driver Brand	Lifud
Socket	N/A
Frequency (Hz)	50 60
Diffuser Material	Polycarbonate
Install Options	BESA/Conduit
Install Type	Push Fit Terminal
Replaceable Driver	Professional
Replaceable LED	Professional
Body Material	Steel
Maintained	Maintained/Non-Maintained
Sensor Technology	Microwave

Technical Specification

Category: Sutton

Part Number: 430038

Description: Sutton Batten 4ft Single 19W 4000K White

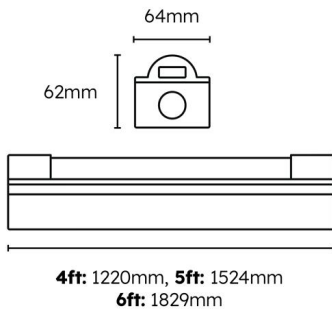

Compatible Products:



401752

Alwen ON/OFF PIR External
Mount White (Batten)

401755

Alwen ON/OFF PIR Remote
(Batten)